

Sheet: console

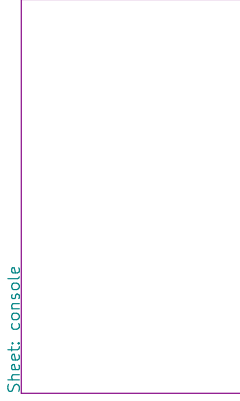

Sheet: cpu

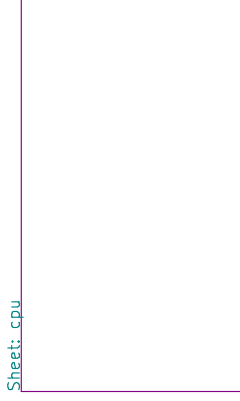

Sheet: ide

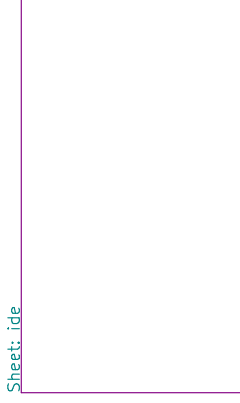

Sheet: iot

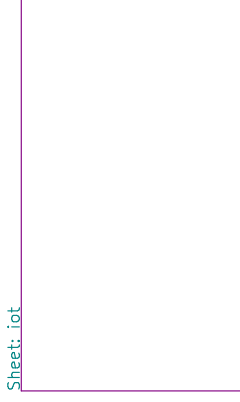

File: console.sch

File: cpu.sch

File: ide.sch

File: iot.sch

Sheet: memory

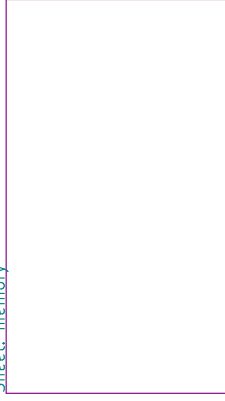

File: memory.sch

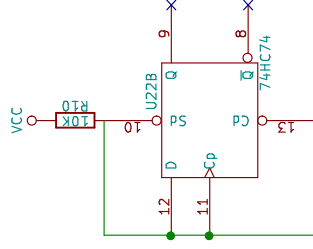
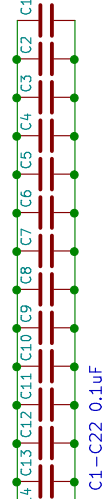
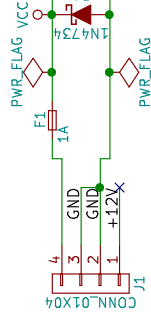
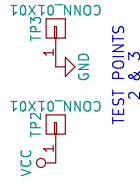

SPARE:  
UNUSED INPUTS MUST  
BE HELD HIGH OR LOW



3.2MM MOUNTING HOLES

SPARETIMEGIZMOS  
SPARE TIME GIZMOS LOGO  
LOGO1

Licensed under the GNU Free Documentation License, Version 1.1  
 Portions (c) 2001–2001 by Spare Time Gizmos, www.sparetimegizmos.com  
 RBC Edition updates/layout (c) 2016 Andrew Bingham  
**RetroBrew Computers, www.retrobrewcomputers.org**

Sheet: /  
File: SBC6120-RBC.sch

**Title: SBC6120-RBC Edition**

Size: A4 | Date: 2016-06-11

KiCad E.D.A. kicad 4.0.2+e4-622538ubuntu14.04.1-stable

Rev: **DRAFT 1.00**

Id: 1/6

- NOTES:
1. CHANGED EMA[0..2] to MA[12..14]; KICAD DOES NOT SUPPORT HETEROGENEOUS BUSES
  2. RELOCATED POWER INPUT/DECOUPLING CAPS TO TOP LEVEL SHEET
  3. RELOCATED TP2/TP3 TO TOP LEVEL SHEET
  4. RELOCATED SPARE/JUNUSED 74HC74 TO TOP LEVEL SHEET

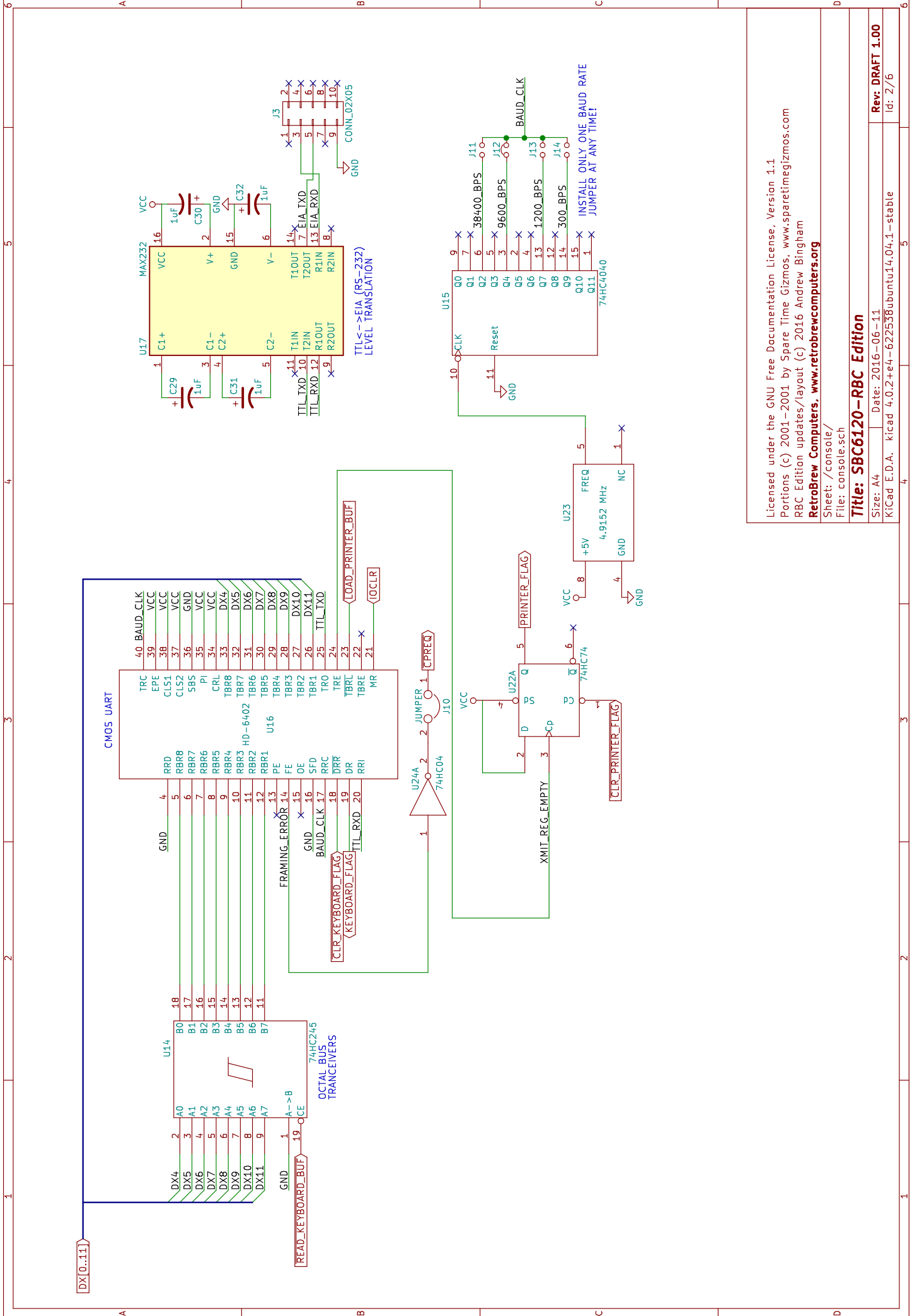

Licensed under the GNU Free Documentation License, Version 1.1  
 Portions (c) 2001–2001 by Spare Time Gizmos, www.sparetimegizmos.com  
 RBC Edition updates/layout (c) 2016 Andrew Bingham  
**RetroBrew Computers, www.retrobrewcomputers.org**  
 Sheet: /console/  
 File: console.sch

**Title: SBC6120–RBC Edition**

Size: A4 | Date: 2016-06-11 | Rev: DRAFT 1.00  
 KiCad E.D.A. kicad 4.0.2+e4-622538ubuntu14.04.1-stable | Id: 2/76

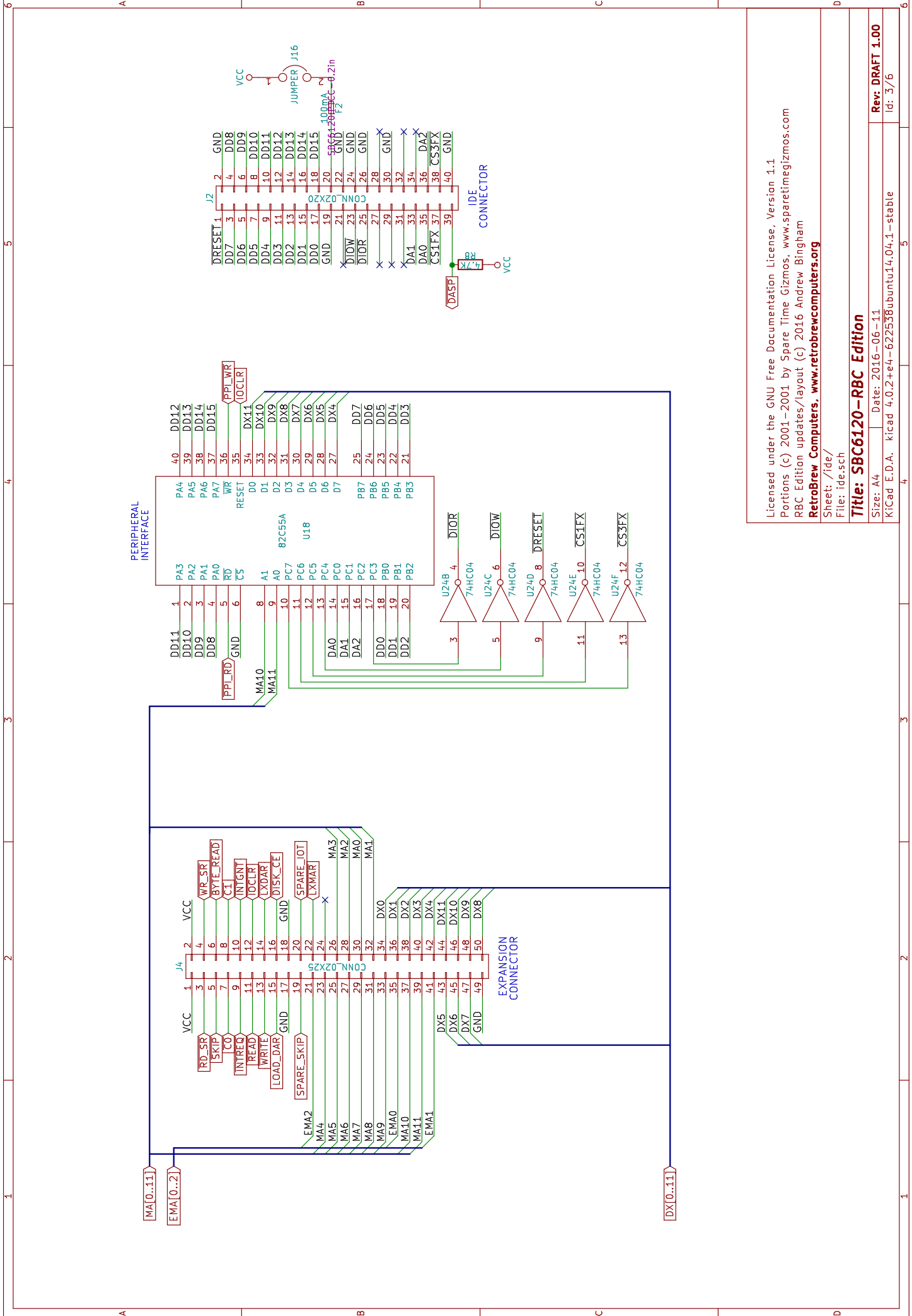

Licensed under the GNU Free Documentation License, Version 1.1  
 Portions (c) 2001–2001 by Spare Time Gizmos, www.sparetimegizmos.com  
 RBC Edition updates/layout (c) 2016 Andrew Bingham  
**RetroBrew Computers, www.retrobrewcomputers.org**  
 Sheet: /Ide/  
 File: ide.sch

**Title: SBC6120–RBC Edition**

Size: A4 | Date: 2016–06–11  
 Kicad E.D.A. kicad 4.0.2+e4–622538ubuntu14.04.1–stable  
 Id: 3/76  
 Rev: DRAFT 1.00

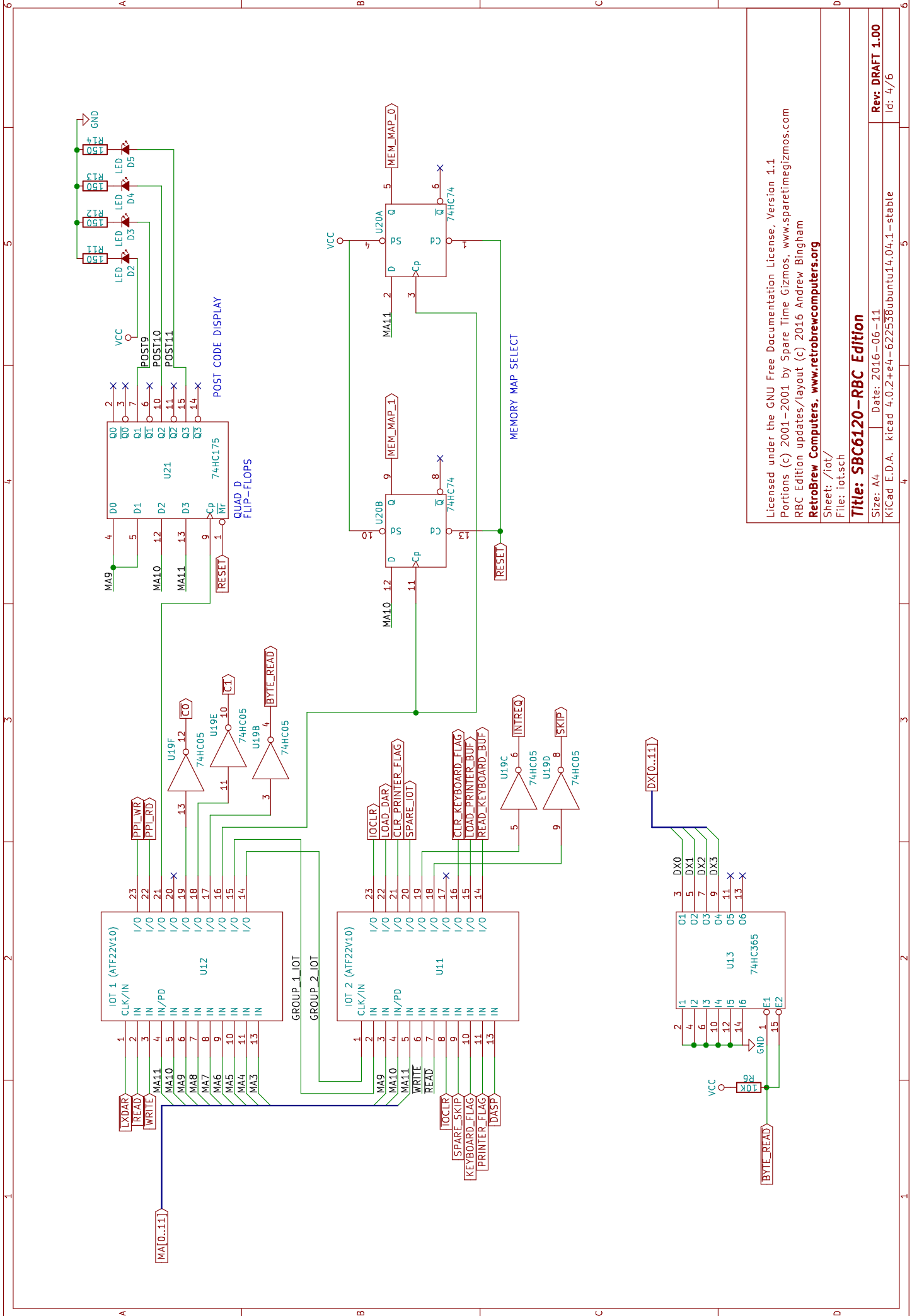

Licensed under the GNU Free Documentation License, Version 1.1  
 Portions (c) 2001–2001 by Spare Time Gizmos, www.sparetimegizmos.com  
 RBC Edition updates/layout (c) 2016 Andrew Bingham  
**RetroBrew Computers, www.retrobrewcomputers.org**  
 Sheet: /iot/  
 File: iot.sch

**Title: SBC6120-RBC Edition**

Size: A4	Date: 2016-06-11
KiCad E.D.A. kicad 4.0.2+e4-622538ubuntu14.04.1-stable	Rev: DRAFT 1.00
	Id: 4/6

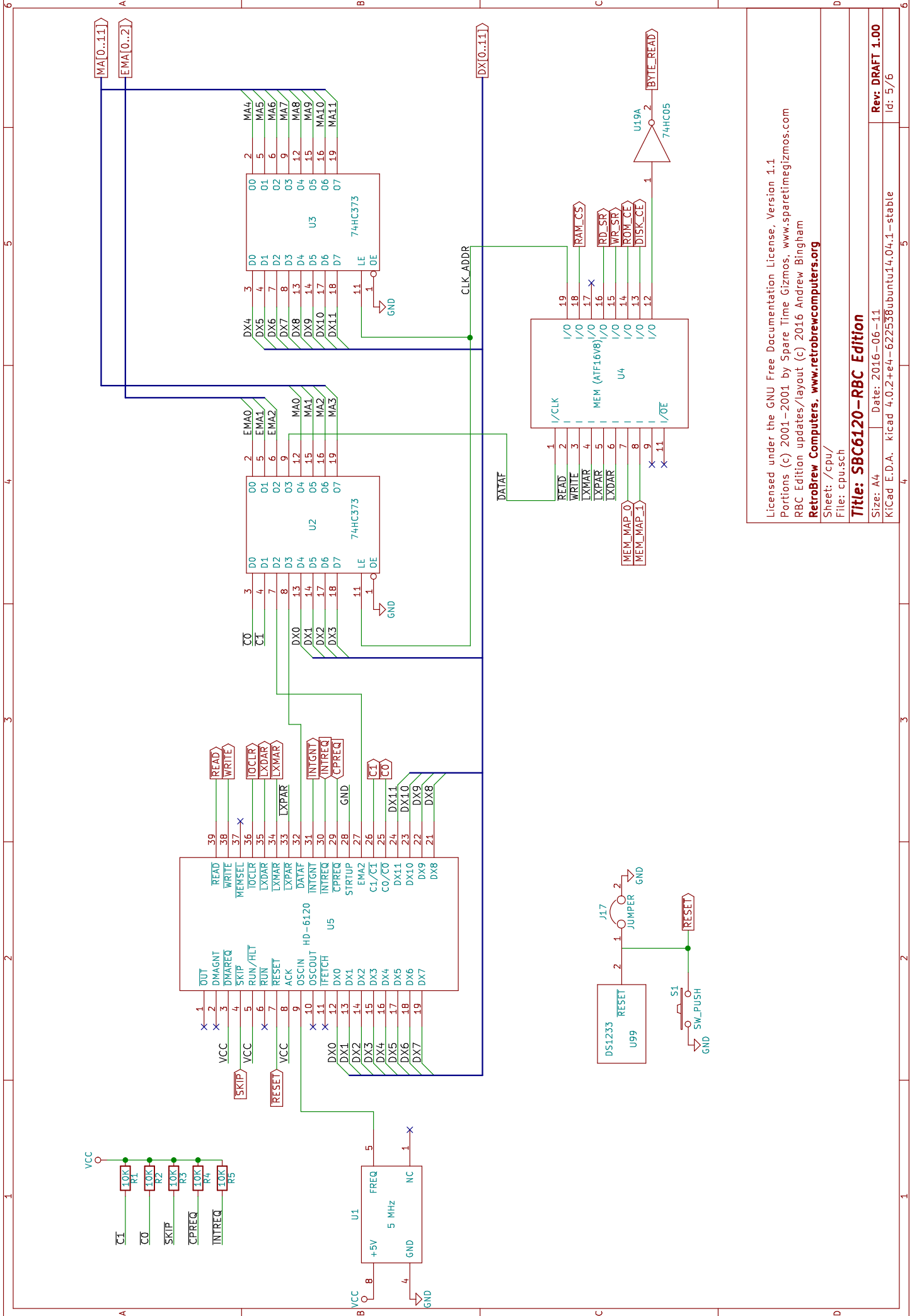

Licensed under the GNU Free Documentation License, Version 1.1  
 Portions (c) 2001–2001 by Spare Time Gizmos, www.sparetimegizmos.com  
 RBC Edition updates/layout (c) 2016 Andrew Bingham  
**RetroBrew Computers, www.retrobrewcomputers.org**  
 Sheet: /cpu/  
 File: cpu.sch

**Title: SBC6120-RBC Edition**

Size: A4 | Date: 2016-06-11 | **Rev. DRAFT 1.00**  
 KiCad E.D.A. kicad 4.0.2+e4-622538ubuntu14.04.1-stable | Id: 5/76

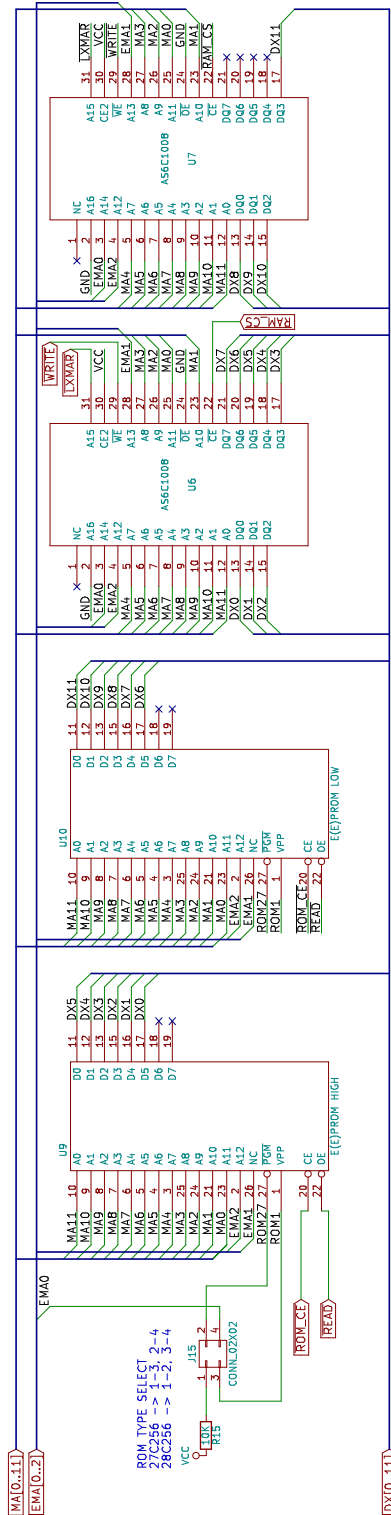

Licensed under the GNU Free Documentation License, Version 1.1  
 Portions (c) 2001-2001 by Spare Time Gizmos, www.sparetimegizmos.com  
 RBC Edition updates/layout (c) 2016 Andrew Bingham  
**RetroBrew Computers, www.retrobrewcomputers.org**  
 Sheet: /memory/  
 File: memory.sch

**Title: SBC6120-RBC Edition**  
 Size: A3  
 Date: 2016-06-11  
 KICad E.D.A., Riced 4.0.2+e4-622938ubuntu14.04.1-stable  
 Rev: DRAFT 1.00  
 Id: 6/6