

Sheet: console

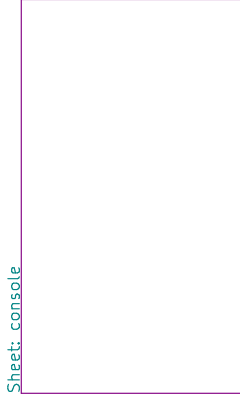

Sheet: cpu

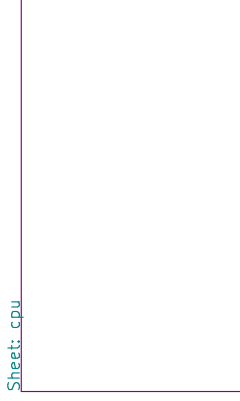

Sheet: ide

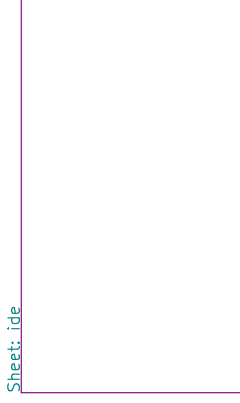

Sheet: iot

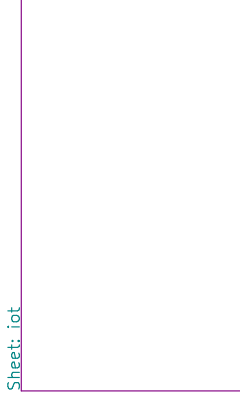

File: console.sch

File: cpu.sch

File: ide.sch

File: iot.sch

Sheet: memory

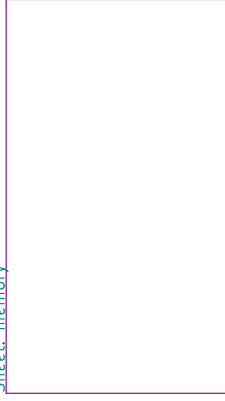

File: memory.sch

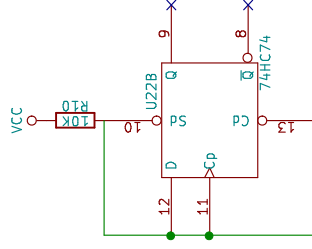
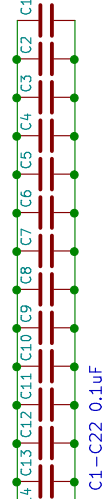
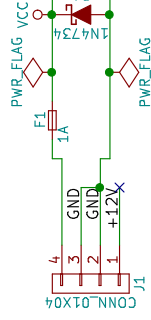
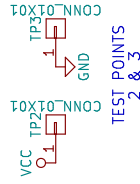

SPARE:
UNUSED INPUTS MUST
BE HELD HIGH OR LOW



3.2MM MOUNTING HOLES

SPARETIMEGIZMOS
SPARE TIME GIZMOS LOGO
LOGO1

Licensed under the GNU Free Documentation License, Version 1.1
 Portions (c) 2001–2001 by Spare Time Gizmos, www.sparetimegizmos.com
 RBC Edition updates/layout (c) 2016 Andrew Bingham
RetroBrew Computers, www.retrobrewcomputers.org

Sheet: /
File: SBC6120-RBC.sch

Title: SBC6120-RBC Edition

Size: A4 Date: 2016-06-15

KiCad E.D.A. kicad 4.0.2+e4-622538ubuntu14.04.1-stable

Rev: DRAFT2 1.00

Id: 1/6

- NOTES:
1. CHANGED EMA[0..2] to MA[12..14]; KICAD DOES NOT SUPPORT HETEROGENEOUS BUSES
 2. RELOCATED POWER INPUT/DECOUPLING CAPS TO TOP LEVEL SHEET
 3. RELOCATED TP2/TP3 TO TOP LEVEL SHEET
 4. RELOCATED SPARE/JUNUSED 74HC74 TO TOP LEVEL SHEET

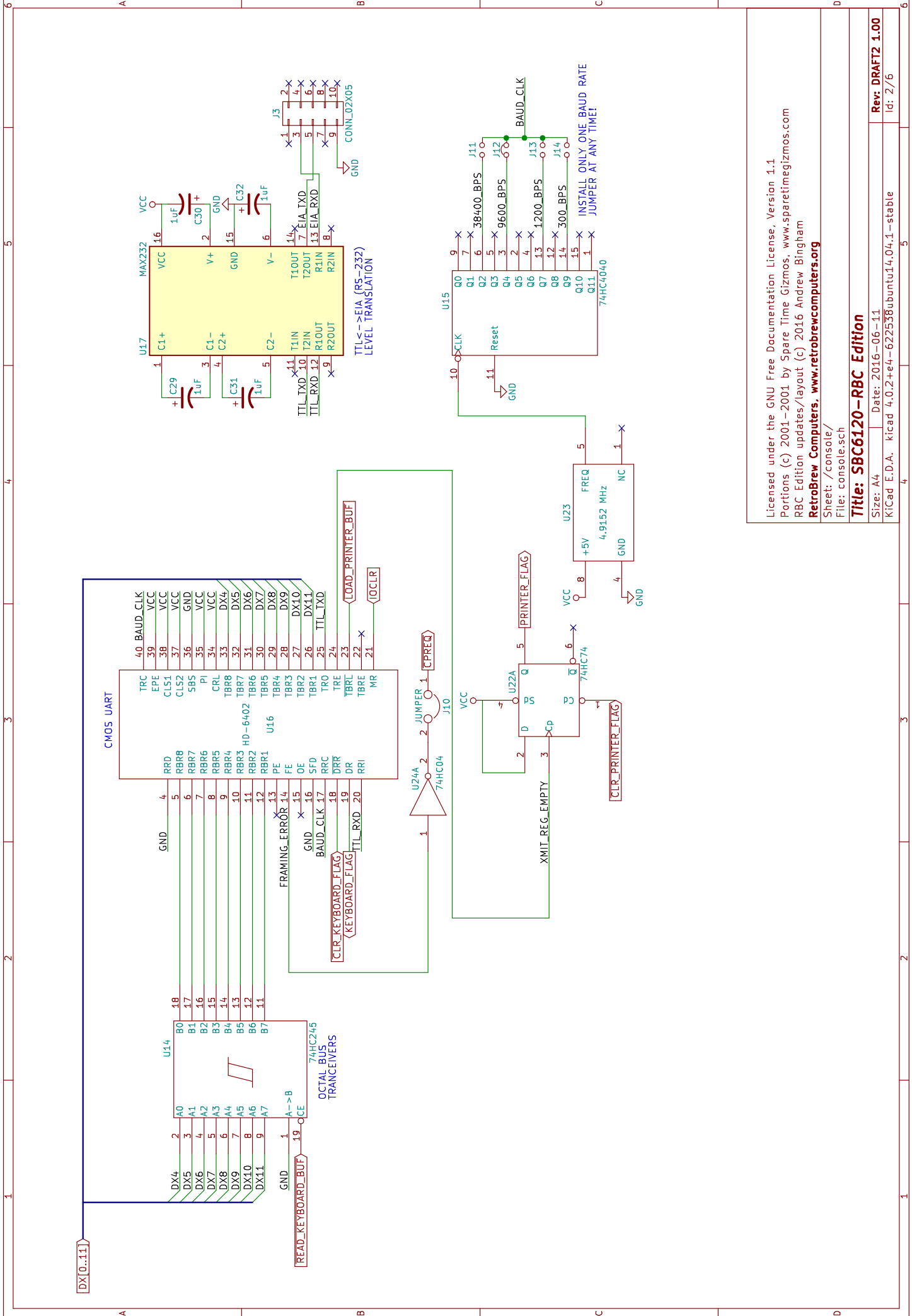

Licensed under the GNU Free Documentation License, Version 1.1
 Portions (c) 2001–2001 by Spare Time Gizmos, www.sparetimegizmos.com
 RBC Edition updates/layout (c) 2016 Andrew Bingham
RetroBrew Computers, www.retrobrewcomputers.org
 Sheet: /console/
 File: console.sch

Title: SBC6120-RBC Edition

Size: A4 | Date: 2016-06-11 | Rev: DRAFT2 1.00
 KiCad E.D.A. kicad 4.0.2+e4-622538ubuntu14.04.1-stable | Id: 2/76

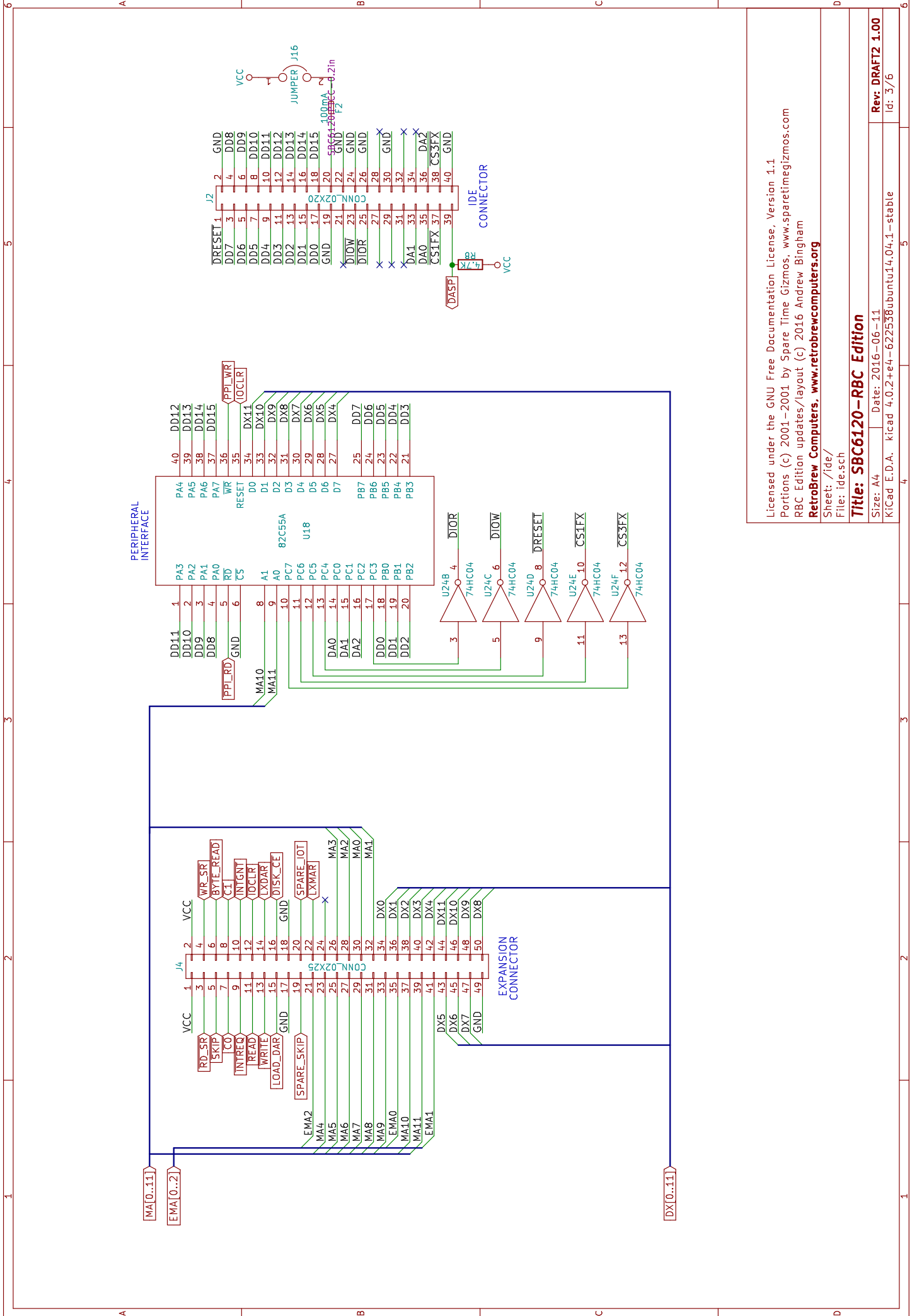

Licensed under the GNU Free Documentation License, Version 1.1
 Portions (c) 2001–2001 by Spare Time Gizmos, www.sparetimegizmos.com
 RBC Edition updates/layout (c) 2016 Andrew Bingham
RetroBrew Computers, www.retrobrewcomputers.org
 Sheet: /Ide/
 File: ide.sch

Title: SBC6120-RBC Edition

Size: A4 | Date: 2016-06-11
 Rev: DRAFT2 1.00
 Kicad E.D.A. kicad 4.0.2+e4-622538ubuntu14.04.1-stable
 Id: 3/76

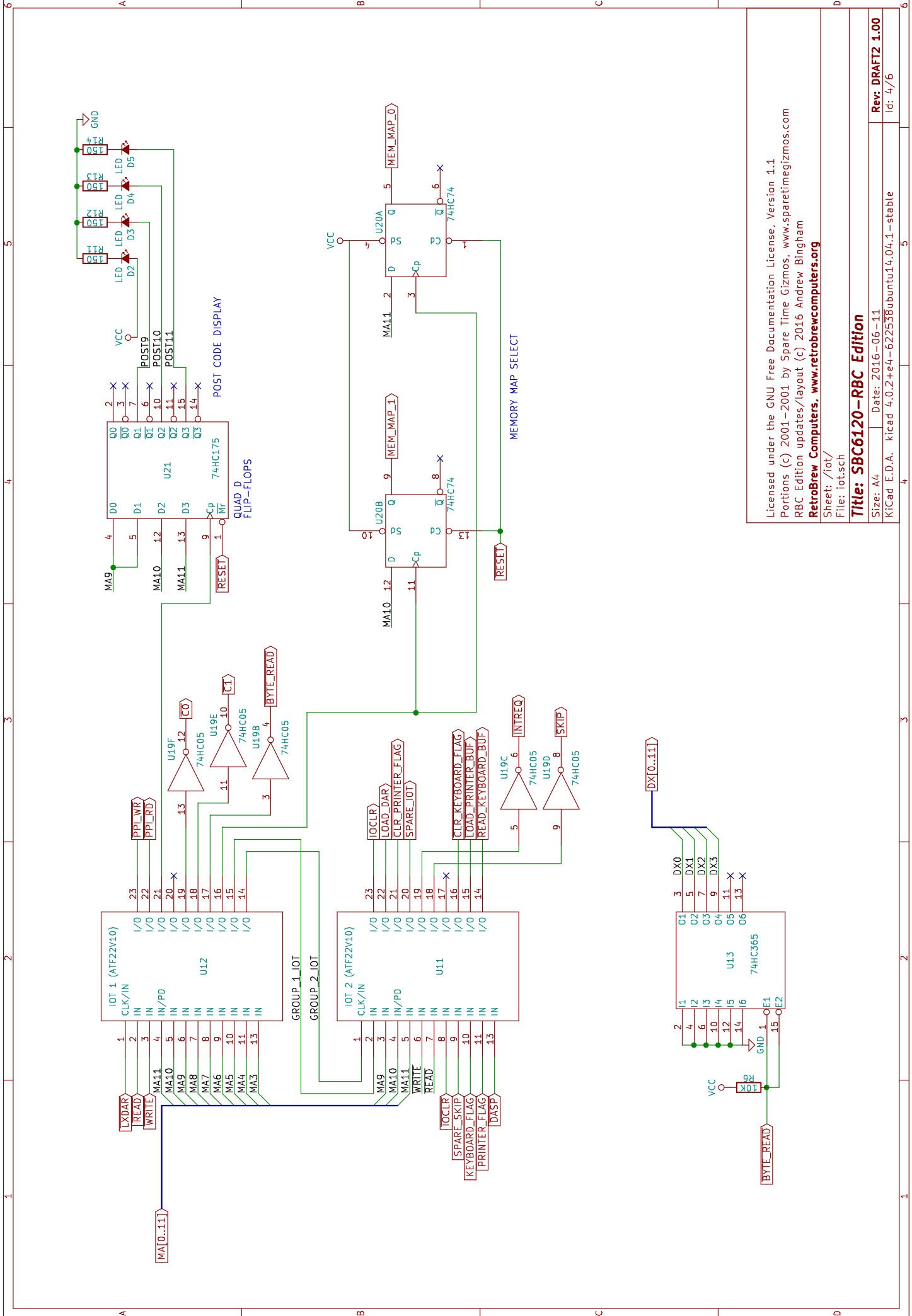

Licensed under the GNU Free Documentation License, Version 1.1
 Portions (c) 2001–2001 by Spare Time Gizmos, www.sparetimegizmos.com
 RBC Edition updates/layout (c) 2016 Andrew Bingham
RetroBrew Computers, www.retrobrewcomputers.org
 Sheet: /iot/
 File: iot.sch

Title: SBC6120-RBC Edition

Size: A4	Date: 2016-06-11
KiCad E.D.A. kicad 4.0.2+e4-622538ubuntu14.04.1-stable	Rev: DRAFT2 1.00
	Id: 4/6

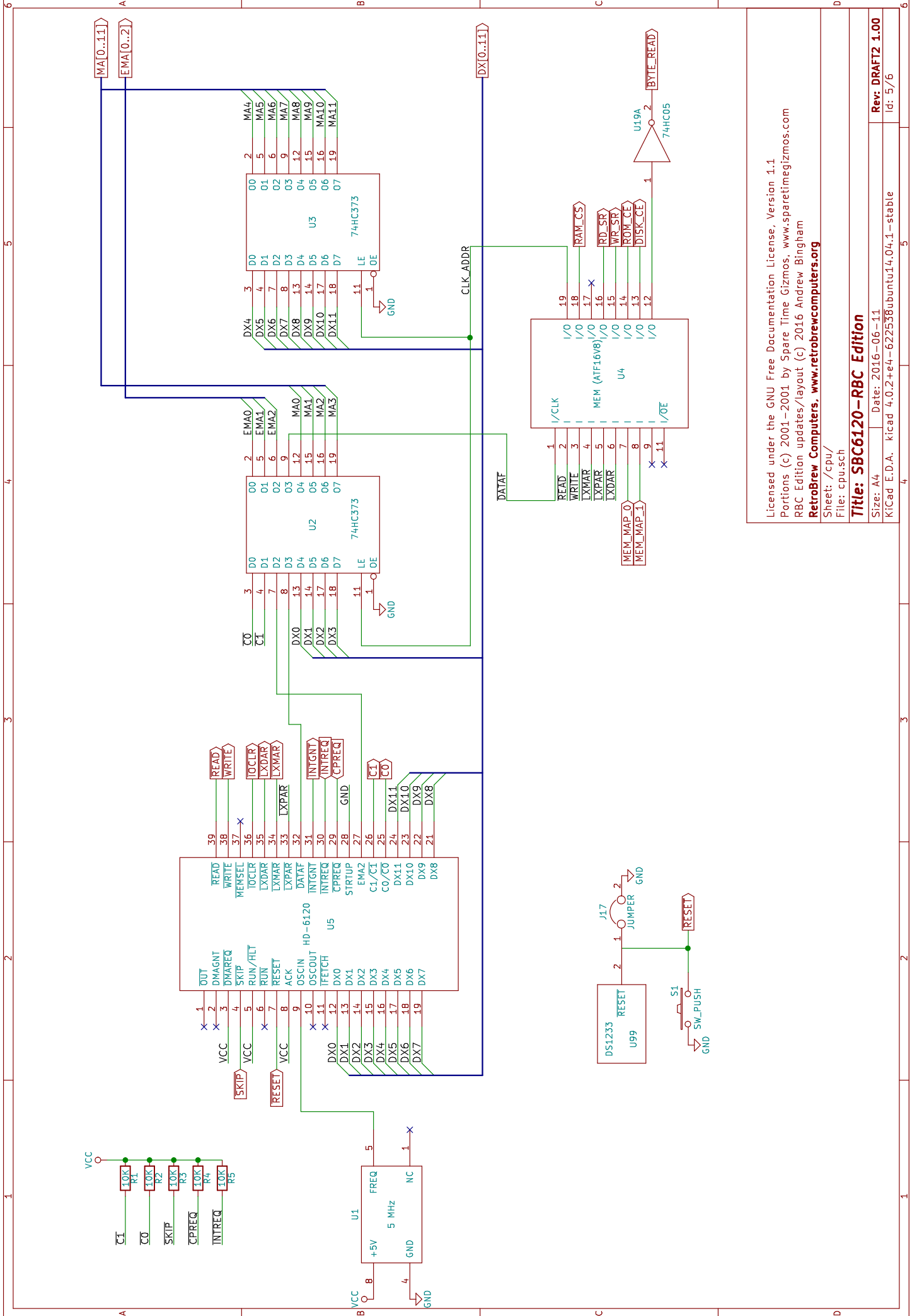

Licensed under the GNU Free Documentation License, Version 1.1
 Portions (c) 2001–2001 by Spare Time Gizmos, www.sparetimegizmos.com
 RBC Edition updates/layout (c) 2016 Andrew Bingham
RetroBrew Computers, www.retrobrewcomputers.org
 Sheet: /cpu/
 File: cpu.sch

Title: SBC6120-RBC Edition

Size: A4	Date: 2016-06-11	Rev: DRAFT2 1.00
KiCad E.D.A. kicad 4.0.2+e4-622538ubuntu14.04.1-stable		Id: 5/6

